

A		4x25	x8
---	--	------	----

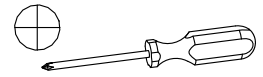

1

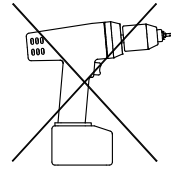
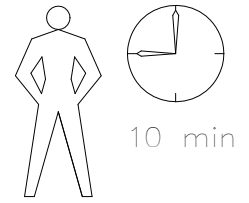
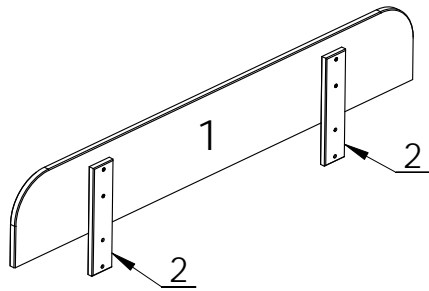
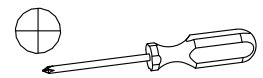
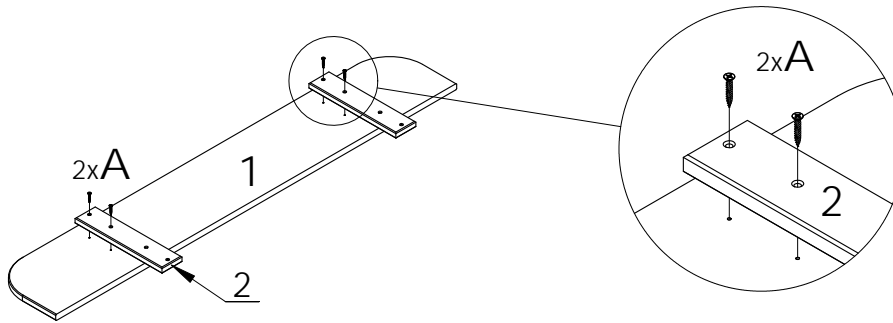

A		4x25	x4
---	--	------	----

2

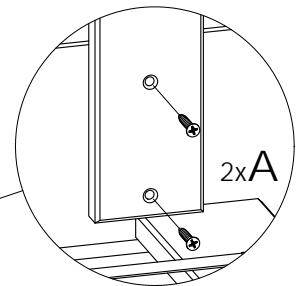
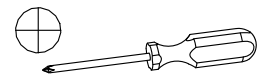
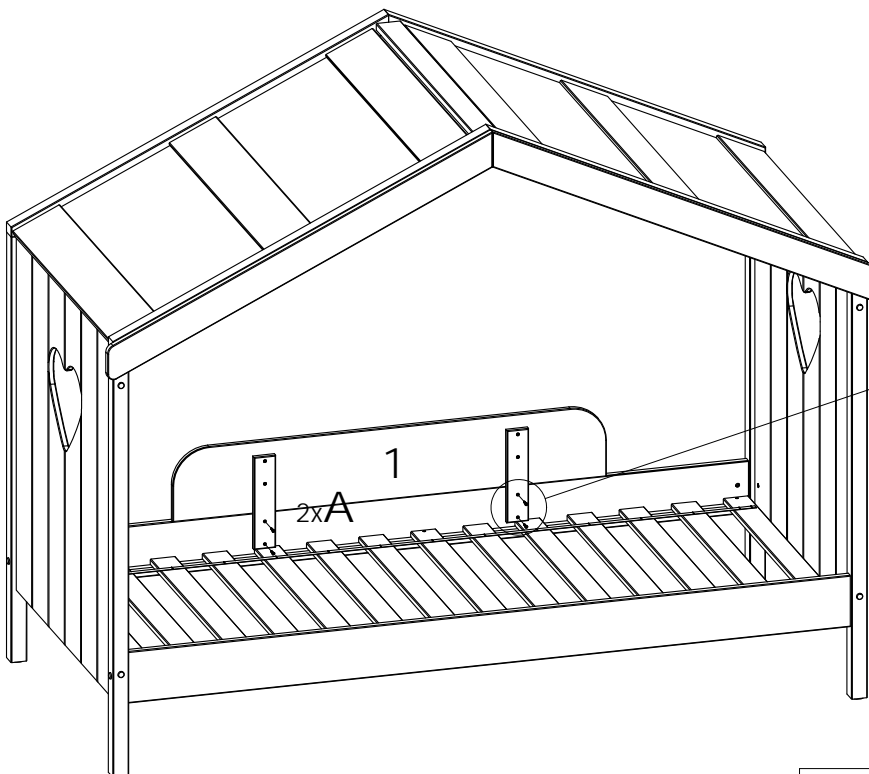

A		4x25	x4
---	--	------	----